Service constraints at Benalla (BN) Zone Substation

Regulatory Investment Test for Distribution



Draft Project Assessment Report

Published: 19 July 2022

ISSUE/AMENDMENT STATUS

Issue	Date	Description	Author	Approved
1	12/07/2022	First Issue	Murtaza Latif	Shane Carr

Disclaimer

This document belongs to AusNet Services and may or may not contain all available information on the subject matter this document purports to address.

The information contained in this document is subject to review and AusNet Services may amend this document at any time. Amendments will be indicated in the Amendment Table, but AusNet Services does not undertake to keep this document up to date.

To the maximum extent permitted by law, AusNet Services makes no representation or warranty (express or implied) as to the accuracy, reliability, or completeness of the information contained in this document, or its suitability for any intended purpose. AusNet Services (which, for the purposes of this disclaimer, includes all of its related bodies corporate, its officers, employees, contractors, agents and consultants, and those of its related bodies corporate) shall have no liability for any loss or damage (be it direct or indirect, including liability by reason of negligence or negligent misstatement) for any statements, opinions, information or matter (expressed or implied) arising out of, contained in, or derived from, or for any omissions from, the information in this document.

Contact

This document is the responsibility of AusNet Services.

Please contact the indicated owner of the document with any inquiries.

Murtaza Latif
AusNet Services
Level 32, 2 Southbank Boulevard
Southbank, Victoria 3006
Ph: (03) 9695 6000

Table of Contents

1	Executive Summary	5
1.1	Identified Need	5
1.2	Options considered and preferred option	6
1.3	Consultation	6
2	Background	7
2.1	Existing network	7
2.2	Customer Composition	8
2.3	Zone Substation Equipment	9
2.3.1	Primary Equipment	9
2.3.2	Secondary Equipment	9
3	Identified Need	10
4	Assumptions underpinning the identified need	11
4.1	Regulatory Obligations	11
4.2	Asset Condition	12
4.3	Zone Substation Supply Capacity	13
4.4	Load Duration Curves	13
4.5	Feeder Circuit Supply Capacity	14
4.6	Load Transfer Capability	14
4.7	Station Configuration Supply Risk	15
5	Potential Credible Options	16
5.1	Option 1: Do Nothing	16
5.2	Option 2: Retire one transformer	16
5.3	Option 3: Retire one transformer and reduce residual risk through network support	16
5.4	Option 4: Network support to defer replacement.....	17
5.5	Option 5: Replace 66kV circuit breakers and poor condition 22kV circuit breakers	17
5.6	Option 6: Replace 66kV circuit breakers and all 22kV circuit breakers	17
5.7	Option 7: Replace 66kV and 22kV circuit breakers and form a ring bus	17
6	Economic assessment of the credible options	18
6.1	Market benefits	18
6.2	Methodology	18
6.3	Key variables and assumptions.....	20
6.4	Cost benefit analysis	21
6.4.1	Present value analysis using central estimates	22
6.4.2	Sensitivity testing and scenario analysis	23
6.5	Preferred option.....	25
6.6	Capital and operating costs of the preferred option.....	25

Service constraints at BN – Draft Project Assessment Report

7	Satisfaction of the RIT-D	26
	Appendix – Technical Characteristics	28
	Scope of works	28
	Technical assumptions	29
	Sequencing of wokrs	30

1 Executive Summary

AusNet Services is a regulated Victorian Distribution Network Service Provider (DNSP) that supplies electrical distribution services to more than 745,000 customers. Our electricity distribution network covers eastern rural Victoria and the fringe of the northern and eastern Melbourne metropolitan area.

As expected by our customers and required by the various regulatory instruments that we operate under, AusNet Services aims to maintain service levels at the lowest possible cost to our customers. To achieve this, we develop forward looking plans that aim to maximise the present value of economic benefit to all those who produce, consume and transport electricity in the National Electricity Market (NEM).

Our planning approach includes the application of a probabilistic planning methodology, under which conditions often exist where some of the load cannot be supplied under rare but possible conditions, such as during extreme demand conditions or with a network element out of service. Where relevant, we also prepare, publish, and consult on a regulatory investment test for distribution (RIT-D), which further helps ensure all credible options are identified and considered, and the best option is selected.

This Draft Project Assessment Report (DPAR) is the second stage of the RIT-D consultation process to address the existing and emerging service level constraints in the Benalla Zone Substation (BN) supply area. It follows the publication of our non-network options report, which invited non-network proponents to engage on alternatives to our preferred network solution. We did not receive any submissions in response to that report.

This DPAR has been prepared by AusNet Services in accordance with the requirements of clause 5.17 of the National Electricity Rules (NER). This DPAR complies with the requirements of Clause 5.17.4(j) of the NER, as detailed in section 7 of this document, and the AER's RIT - D application guidelines.

1.1 Identified Need

BN was first established in the 1940s and consists of three 10/13.5 MVA 66/22kV transformers supplied from two 66kV lines emanating from Glenrowan Terminal Station (GNTS). It has a third 66 kV line that radially supplies Mansfield (MSD) and Merrijig (MJG) Zone Substations.

The station has mixture of bulk oil and vacuum circuit breakers, and the physical and electrical condition of some assets has deteriorated and they are now presenting an increased failure risk.

The emerging service constraints at BN are:

- Security of supply risks presented by the increasing likelihood of asset failure due to the condition of the assets;
- Health and safety risks presented by a possible explosive failure of the bushings on a number of the assets;
- Plant collateral damage risks presented by a possible explosive failure of bushings on a number of assets;
- Environmental risks associated with insulating oil spill or fire; and
- Reactive asset replacement risks presented by the increasing likelihood of asset failure due to the deteriorating condition of the assets.

Our assessment is that works are required to address the asset-related risks in accordance with our obligations under clause 5.2 of the Electricity Distribution Code, which requires us to meet reasonable customer expectations of reliability of supply.

Service constraints at BN – Draft Project Assessment Report

1.2 Options considered and preferred option

The options considered in this DPAR, which include both credible and non-credible options, are:

1. Do nothing
2. Retire one transformer
3. Retire one transformer and reduce residual risk through network support
4. Network support to defer retirement and replacement
5. Replace 66kV circuit breakers and poor condition 22kV circuit breakers
6. Replace 66kV circuit breakers and all 22kV circuit breakers
7. Replace 66kV circuit breakers and form a ring bus and all 22kV circuit breakers

Our analysis concludes that only Options 5, 6 and 7 are credible options, and the preferred option is Option 6.

Note: Assets operating at 22kV at BN are excluded from this scope as they are included for replacement as part of the REFCL program (DD-7180)

1.3 Consultation

In accordance with Clause 5.17.4(k) of the NER, we request submissions on the matters set out in this DPAR. Notification of this request for submissions will also be provided to Registered Participants, AEMO, non-network providers, interested parties and persons on our demand side engagement register as required by the NER.

Submissions should be sent to ritdconsultations@ausnetservices.com.au by 7 September 2022 and telephone enquiries can be directed to Murtaza Latif on (03) 9695 6000.

Submissions will be published on AusNet Services' website. If you do not wish to have your submission published, please clearly stipulate this at the time of lodging your submission.

2 Background

2.1 Existing network

BN is located approximately 212 km north-east of Melbourne and is the main source of supply for the rural towns of Benalla, Violet Town, Euroa, Lima South, Tatong, and Goorambat townships. BN supplies approximately 12,100 AusNet Services' customers. The customer base supplied from BN is predominately made up of residential (66%) and farming (24%), with some commercial and industrial.

The Benalla zone substation supply area is to the north-east of Melbourne, and is at an elevation of 170 m above sea level. BN has typical Melbourne climate with summer average maximum temperatures of 30°C, winter average minimum temperatures of 4°C with extreme temperatures reaching 43.5°C in summer and -4.5°C in winter. The average annual rainfall is 670mm in this area.

BN is supplied at 66kV via two 66kV circuits that originate from Glenrowan Terminal Station (GNTS). The location of BN within the AusNet Services distribution network is as shown in Figure 1.

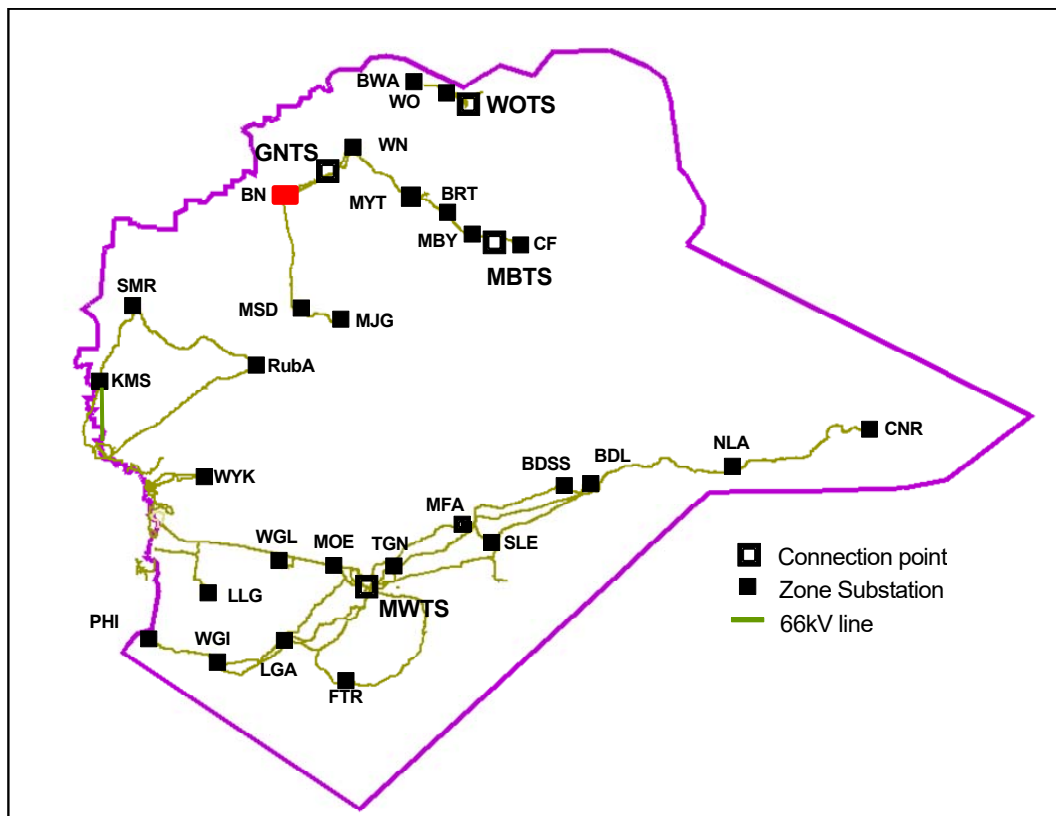

Figure 1: BN location within AusNet Services distribution network

The configuration of primary electrical circuits within BN is as shown in the single line diagram in Figure 2.

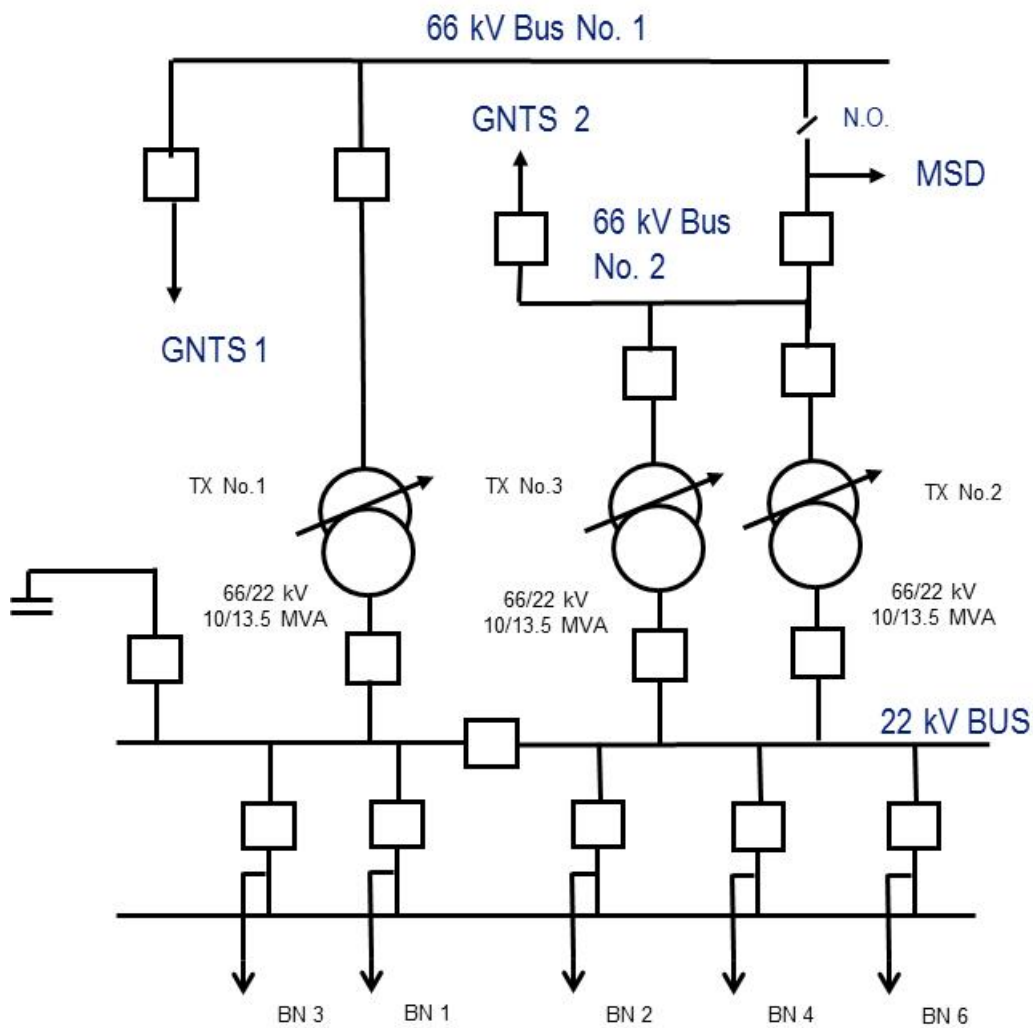

Figure 2: BN Single Line Diagram

2.2 Customer Composition

BN has five 22kV feeders of which supply into the AusNet Services supply area.

Table 1 provides details of the 22kV supply feeders.

Table 1: BN feeder information

Feeder	Feeder Length (km)	Feeder description	Number of Customers	Type of Customers
BN11	1206	Summer peaking, long rural feeder	4608	58.9% Residential 9.2% Commercial 1% Industrial 30.8% Farming
BN24	384	Summer peaking, long rural feeder	1084	47.5% Residential 14.2% Commercial 3.1% Industrial 35.2% Farming

Service constraints at BN – Draft Project Assessment Report

Feeder	Feeder Length (km)	Feeder description	Number of Customers	Type of Customers
BN12	153	Summer peaking, short rural feeder	662	71.9% Residential 3.9% Commercial 1.2% Industrial 23.0% Farming
BN22	19	Summer Peaking, urban, feeder	3381	87.6% Residential 11.6% Commercial 0.7% Industrial 0.1% Farming
BN23	506	Summer peaking, long rural feeder	2355	63.2% Residential 4.9% Commercial 0.8% Industrial 31.1% Farming

There is minimal inter-connecting 22kV feeders between Benalla Zone Substation and its adjacent zone substations.

2.3 Zone Substation Equipment

2.3.1 Primary Equipment

BN includes an air-insulated 66kV switchyard with two 66kV buses separated by bus-tie circuit breakers connected to two incoming 66kV lines from GNTS and one outgoing to MSD ZS. The switching is done by six AEI LGC4C bulk oil type 66 kV circuit breakers.

There are two 22kV air insulated busbars connected to one another with a bus-tie circuit breaker and connected to the three 66/22kV transformers via three transformer circuit breakers. Five 22kV feeders and one 6MVar capacitor bank are connected to these 22kV busbars.

The 22kV switchyard currently has three EMAIL 345GC type 22kV bulk oil circuit breakers and one OMT2/3 type 22 kV bulk oil type circuit breaker, all of which are in C5 condition. There are also four 22 kV vacuum type circuit breakers, which have mechanical problems.

Transformation comprises of three 10/13.5MVA 66/22kV transformers. The No.1 and No.2 units were manufactured by Tyree, and the No.3 unit was manufactured by English Electric. All the transformers are in C3 condition and were installed at BN zone substation in the late 1960s to early 1970s.

2.3.2 Secondary Equipment

The three incoming 66kV lines and two buses are protected by current distance and remote trip send and directional overcurrent protection using modern SEL 311C and GE D30 relays.

The No.1 and No.2 66/22kV transformer differential protection is provided by older RYDSA relays whilst the newer No.3 transformer differential protection is provided by modern ABB D202 relays. The 22kV bus protection consists of distance bus protection and differential protection using GEC CDG14 and GE D30 relays.

The 22kV feeder circuit breakers have master earth fault and back up earth fault protection using GE F35 and GE F650 relays. The 22kV capacitor bank protection has overcurrent, earth fault and voltage balance schemes using a GE F650 relay.

The station has duplicated 24V AC systems and battery chargers that supply a 250V DC system for protection relays and trip coils.

3 Identified Need

BN commenced operation as a 66/22kV transformation station over 80 years ago in the late 1948s with three power transformers. BN is supplied at 66kV via two 66kV circuits that originate from Glenrowan Terminal Station (GNTS). There is one outgoing 66 kV line to MSD Zone Substation.

The station has mixture of bulk oil and vacuum circuit breakers and the physical and electrical condition of some of these assets has deteriorated and they are now presenting an increasing failure risk.

The emerging service constraints at BN are:

- Security of supply risks presented by the increasing likelihood of asset failure due to the condition of the assets;
- Health and safety risks presented by a possible explosive failure of the bushings on a number of the assets
- Plant collateral damage risks presented by a possible explosive failure of bushings on a number of assets
- Environmental risks associated with insulating oil spill or fire; and
- Reactive asset replacement risks presented by the increasing likelihood of asset failure due to the deteriorating condition of the assets.

4 Assumptions underpinning the identified need

The purpose of this chapter is to summarise the key input assumptions that underpin the identified need described in the previous chapter.

4.1 Regulatory Obligations

In addressing the identified need, we must satisfy our regulatory obligations, which we summarise below.

Clause 6.5.7 of the National Electricity Rules requires AusNet Services to only propose capital expenditure required in order to achieve each of the following:

- (1) *meet or manage the expected demand for standard control services over that period;*
- (2) *comply with all applicable regulatory obligations or requirements associated with the provision of standard control services;*
- (3) *to the extent that there is no applicable regulatory obligation or requirement in relation to:*
 - (i) *quality, reliability or security of supply of standard control services; or*
 - (ii) *the reliability or security of the distribution system through the supply of standard control services**to the relevant extent:*
 - (iii) *maintain the quality, reliability and security of supply of standard control services, and*
 - (iv) *maintain the reliability and security of the distribution system through the supply of standard control services; and*
- (4) *maintain the safety of the distribution system through the supply of standard control services.*

Section 98(a) of the Electricity Safety Act requires AusNet Services to:

design, construct, operate, maintain and decommission its supply network to minimise as far as practicable –

- (a) *the hazards and risks to the safety of any person arising from the supply network; and*
- (b) *the hazards and risks of damage to the property of any person arising from the supply network; and*
- (c) *the bushfire danger arising from the supply network.*

The Electricity Safety act defines 'practicable' to mean having regard to –

- (a) *severity of the hazard or risk in question; and*
- (b) *state of knowledge about the hazard or risk and any ways of removing or mitigating the hazard or risk; and*
- (c) *availability and suitability of ways to remove or mitigate the hazard or risk; and*
- (d) *cost of removing or mitigating the hazard or risk.*

Clause 3.1 of the Electricity Distribution Code requires AusNet Services to:

- (b) *develop and implement plans for the acquisition, creation, maintenance, operation, refurbishment, repair and disposal of its distribution system assets and plans for the establishment and augmentation of transmission connections:*

Service constraints at BN – Draft Project Assessment Report

- (i) to comply with the laws and other performance obligations which apply to the provision of distribution services including those contained in this Code;
- (ii) to minimise the risks associated with the failure or reduced performance of assets; and
- (iii) in a way which minimises costs to customers taking into account distribution losses.

Under clause 5.2 of the Electricity Distribution Code, AusNet Services:

must use best endeavours to meet targets required by the Price Determination and targets published under clause 5.1 and otherwise meet reasonable customer expectations of reliability of supply.

4.2 Asset Condition

AMS 10-13 Condition Monitoring describes AusNet Services' strategy and approach to monitoring the condition of assets.

Asset condition is measured with reference to an asset health index on a scale of C1 to C5. Table 2 provides a description of the asset condition scores.

Table 2: Asset condition Score and Remaining Service Potential

Condition Score	Condition	Condition Description
C1	Very Good	Initial service condition
C2	Good	Deterioration has minimal impact on asset performance. Minimal short term asset failure risk.
C3	Average	Functionally sound showing some wear with minor failures, but asset still functions safely at adequate level of service.
C4	Poor	Advanced deterioration – plant and components function but require a high level of maintenance to remain operational.
C5	Very Poor	Extreme deterioration approaching end of life with failure imminent.

The condition of the key assets at BN is discussed in the Asset Health Reports for the key asset classes such as power transformers, instrument transformers and switchgear with information on asset condition rankings, recommended risk mitigation options and replacement timeframes. A summary of the asset condition at BN is provided in Table 3 and discussed in the following sections.

Table 3: BN Asset Condition Summary

Asset Type	Number of assets by Condition Score				
	C1	C2	C3	C4	C5
66kV Circuit Breakers					6
66kV Current Transformers	3				
66kV Voltage Transformers				2	
66/22kV Power Transformers			3		
22kV Circuit Breakers		2	4		5
22kV Current Transformers					3
22kV Voltage Transformers	1			2	

These condition scores are then used to calculate the asset failure rates using the Weibull parameters determined for each asset class.

4.3 Zone Substation Supply Capacity

BN is a summer peaking station and the peak electrical demand reached 35.1MVA in summer 2019/20, and is forecast to grow slowly at approximately 0.4% per annum to 35.3MVA by 2024/25

Figure 3 shows the forecast maximum demand and supply capacities (cyclic ratings) for BN.

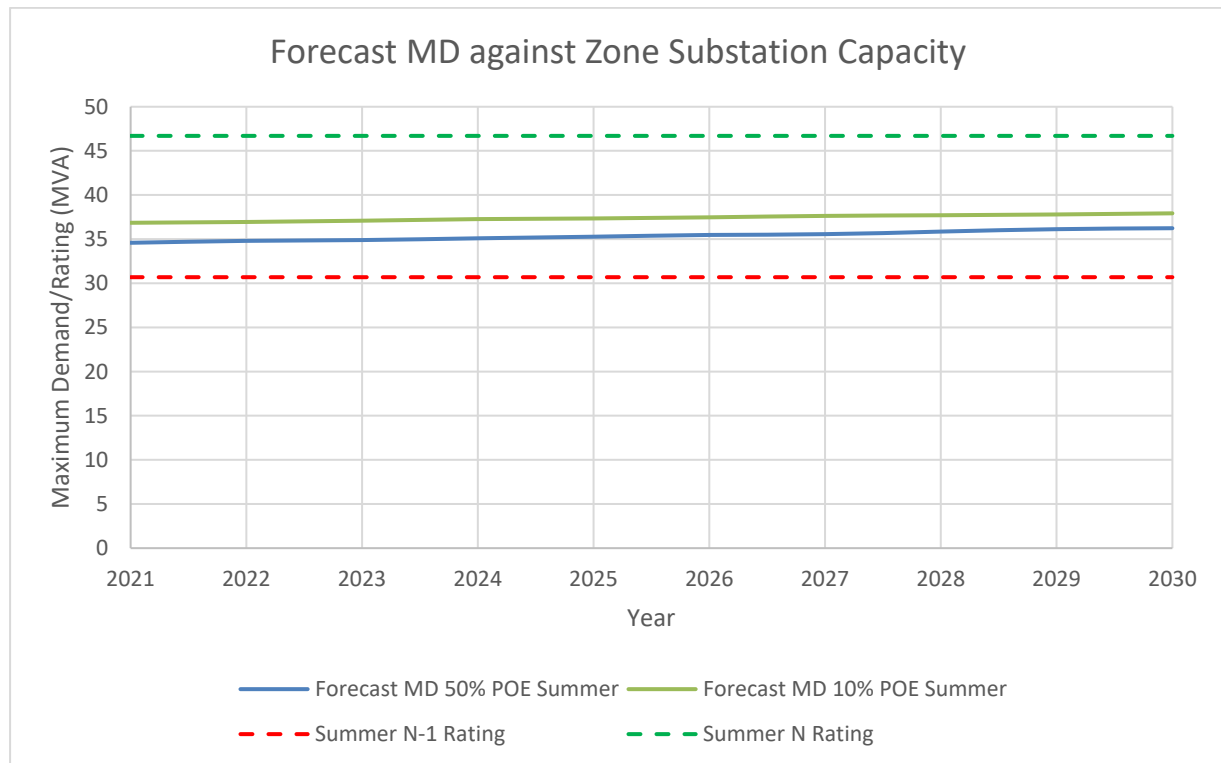

Figure 3: BN Forecast Maximum Demand against Zone Substation Capacity

4.4 Load Duration Curves

The zone substation load duration curves that feed into the risk-cost assessment model are derived from historical actual demands between:

- 1 October 2019 and 31 March 2020 for the summer 50% probability of exceedance (POE) curves;
- 1 April 2020 and 30 September 2020 for the winter 50% POE curves;
- 1 October 2019 and 31 March 2020 for the summer 10% POE curves; and
- 1 April 2020 and 30 September 2020 for the winter 10% POE curves.

The historical hourly demands are separated by season and unitised based on the recorded maximum demand within that season (summer and winter) and time period, which allows the load duration curve to be scaled according to the seasonal forecast maximum demand for each year of the assessment period.

The 50% POE unitised load duration for BN zone substation is presented in Figure 4, and the 10% POE unitised load duration for BN zone substation is presented in Figure 5.

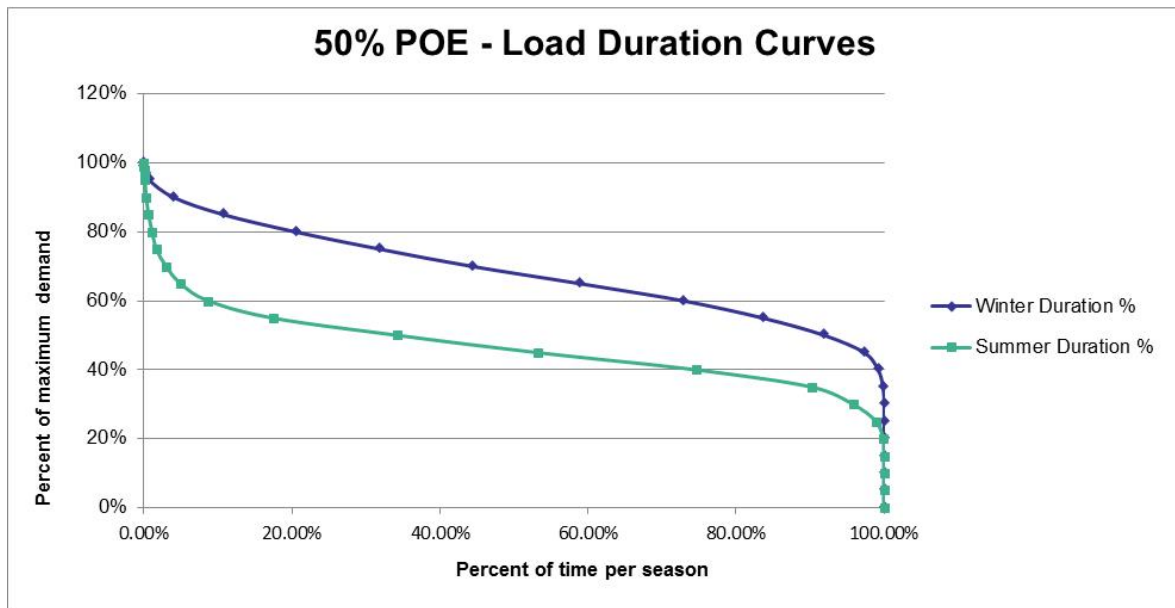

Figure 4: BN 50% Load Duration Curves

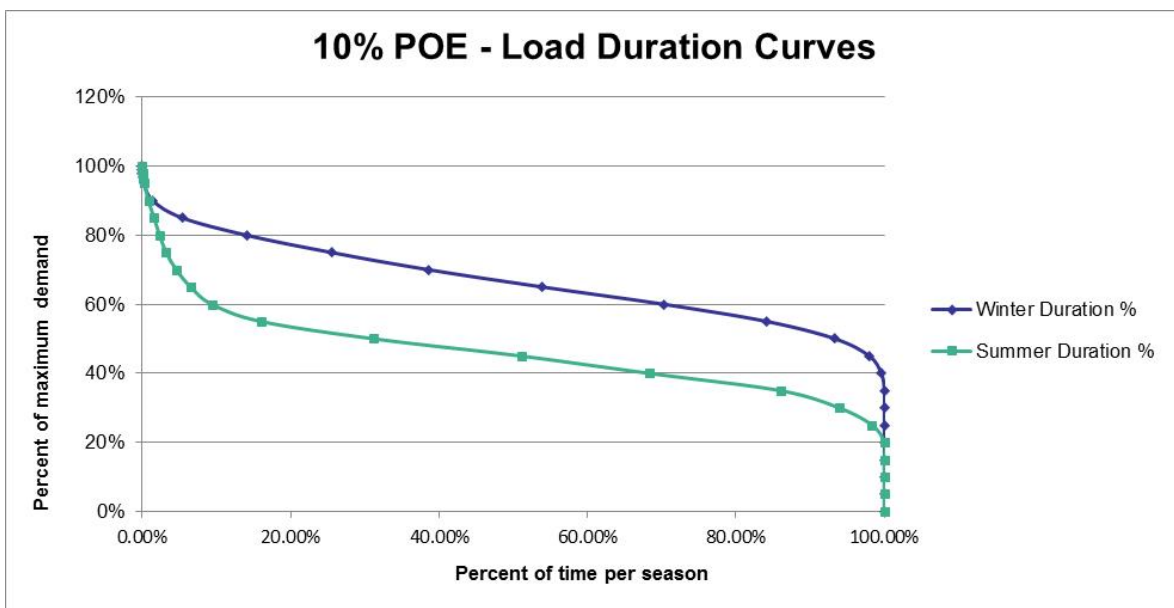

Figure 5: BN 10% POE Load Duration Curves

4.5 Feeder Circuit Supply Capacity

There is currently no requirement for additional feeders at BN due to the modest load growth expected in the supply area.

4.6 Load Transfer Capability

The Distribution Annual Planning Report (DAPR) provides the load transfer capability (in MW) of the feeder interconnections between BN and its neighbouring zone substations. Our forecast load transfer capability is set out in Table 4.

Service constraints at BN – Draft Project Assessment Report

Table 4: BN Load Transfer Capability

	2021	2022	2023	2024	2025	2026	2027	2028	2029	2030
Load Transfer Capability (MW)	1.6	1.6	1.6	1.6	1.6	1.6	1.6	1.6	1.6	1.6

4.7 Station Configuration Supply Risk

Failure of some 22kV equipment will result in supply outages to customers as backup circuit breakers operate to isolate the failed equipment. These customer outages would be for an estimated duration of two hours, which is the typical time it takes operators to travel to site and manually re-configure circuits to isolate the failed equipment and sequentially restore supply to as many customers as possible.

Table 5 lists the estimated 22kV bus outage consequence factors for each major type of equipment based on the zone substation layout.

Table 5: BN Bus Outage Consequence Factors

Equipment	Estimated 22kV Bus Outage Consequence
22kV circuit breaker	55%
22kV current transformer	55%
22kV voltage transformer	50%

5 Potential Credible Options

This section outlines the potential options that have been considered to address the identified need, and summarises the key works and costs associated with implementing these options. In subsequent analysis some of these options have been found not to be credible but are nevertheless included here for completeness.

The following options were considered in seeking to address the risks at BN:

1. Do nothing
2. Retire one transformer
3. Retire one transformer and reduce residual risk through network support
4. Network support to defer retirement and replacement
5. Replace 66kV circuit breakers and poor condition 22kV circuit breakers
6. Replace 66kV circuit breakers and all 22kV circuit breakers
7. Replace 66kV and 22kV circuit breakers and form a ring bus

Each of the network options to address the identified need would need to be delivered during the 2021-25 EDPR period.

Note: Assets operating at 22kV at BN are excluded from this scope as they are included for replacement as part of the REFCL program (DD-7180).

5.1 Option 1: Do Nothing

The Do Nothing (counterfactual) option assumes that AusNet Services would not undertake any investment, outside of the normal operational and maintenance processes. Under this option, increasing supply risk would be managed by increased levels of involuntary load reduction. Increased non-supply risks, such as those associated with safety, collateral damage, reactive replacement and environmental impacts, would be accepted as unmanaged rising risk costs.

The Do Nothing (counterfactual) option establishes the base level of risk, and provides a basis for comparing potential options.

5.2 Option 2: Retire one transformer

This option tests whether the current installed capacity of the substation is still required to meet customer demand and whether equipment could be retired rather than replaced.

Our analysis shows that this option would increase the expected unserved energy and would produce a negative net present value (NPV) compared to the 'Business as Usual' option. Furthermore, the retirement of one transformer would not address the asset-related risks described in the identified need. On that basis, this option is not credible and is not considered further.

5.3 Option 3: Retire one transformer and reduce residual risk through network support

This option supplements Option 2 by examining whether the addition of network support would provide a cost effective means of eliminating residual risk and therefore produce a higher net market benefit. The cost of obtaining network support will be the principal direct cost associated with this option, with capital expenditure of approximately \$130k for the associated decommissioning works and setting up a network support agreement.

The purpose of the non-network options report was to test with non-network proponents whether this option is feasible and to better understand the likely costs of procuring network support. No submissions were received from non-network proponents and, therefore, this

option is no longer considered to be credible. This option is not considered further in this DPAR.

5.4 Option 4: Network support to defer replacement

This option extends Option 3 to consider whether sufficient network support could be provided to avoid entirely the proposed retirement and replacement of the network assets, i.e. a network support only solution.

As noted in relation to Option 3, this option will involve relatively modest direct costs to decommission assets and set up a network support agreement. The principal costs of this option is the cost of procuring network support. As we received no responses to the non-network options report, this option is no longer considered credible and is not considered further in this DPAR.

5.5 Option 5: Replace 66kV circuit breakers and poor condition 22kV circuit breakers

This option replaces the six condition five 66kV circuit breakers, and five condition five 22 kV circuit breakers in situ.

The estimated capital cost for this option is \$8.38 million in real 2022 dollars, including overheads..

5.6 Option 6: Replace 66kV circuit breakers and all 22kV circuit breakers

This option replaces the six condition five 66kV circuit breakers in situ and replaces the existing 22kV switchgear with two new indoor 22kV switchboards.

The estimated capital cost for this option is \$10.05 million in real 2022 dollars, including overheads.

5.7 Option 7: Replace 66kV and 22KV circuit breakers and form a ring bus

This option replaces the six condition five 66 kV circuit breakers, and rearranges the 66 kV switchyard to form a 66kV ring bus, and replaces the existing 22 kV switchgear with two new indoor 22kV switchboards.

The estimated capital cost for this option is \$17.6 million in real 2022 dollars, including overheads..

6 Economic assessment of the credible options

6.1 Market benefits

The regulatory investment test for distribution requires the RIT-D proponent to consider whether each credible option provides the classes of market benefits described in clause 5.17.1(c)(4) of the NER. To address this requirement, the table below discusses our approach to each of the market benefits listed in clause 5.17.1(c)(4) in assessing the credible options to address the identified need at BN.

Table 6: Analysis of Market Benefits

Class of Market Benefit	Analysis
<i>(i) changes in voluntary load curtailment;</i>	The options are not expected to lead to changes in voluntary load curtailment.
<i>(ii) changes in involuntary load shedding and customer interruptions caused by network outages, using a reasonable forecast of the value of electricity to customers;</i>	The options are expected to have an impact on involuntary load shedding, although the identified need relates to asset condition. The cost benefit analysis will therefore consider the impact of each option on load shedding. AusNet Services applies probabilistic planning techniques to assess the expected cost of unserved energy for each option.
<i>(iii) changes in costs for parties, other than the RIT-D proponent, due to differences in:</i> <i>(A) the timing of new plant;</i> <i>(B) capital costs; and</i> <i>(C) the operating and maintenance costs;</i>	There is no impact on other parties.
<i>(iv) differences in the timing of expenditure;</i>	This project will not result in changes in the timing of other expenditure.
<i>(v) changes in load transfer capacity and the capacity of Embedded Generators to take up load;</i>	This project will not impact on the capacity of Embedded Generators to take up load.
<i>(vi) any additional option value (where this value has not already been included in the other classes of market benefits) gained or foregone from implementing the credible option with respect to the likely future investment needs of the National Electricity Market;</i>	This project will not impact the option value in respect to likely future investment needs of the NEM.
<i>(vii) changes in electrical energy losses; and</i>	This project will not result in changes to electrical energy losses.
<i>(viii) any other class of market benefit determined to be relevant by the AER.</i>	We do not consider any other class of market benefit as relevant to the selection of the preferred option.

6.2 Methodology

The purpose of this section is to provide a high-level explanation of our methodology for identifying the preferred option. As a general principle, it is important that the methodology takes account of the identified need and the factors that are likely to influence the choice of the preferred option. As such, the methodology is not a ‘one size fits all’ approach, but one that is tailored for the particular circumstances under consideration.

The identified need for this project can be described in terms of two types of risk:

Service constraints at BN – Draft Project Assessment Report

- supply risk, where an asset failure may lead to a loss of supply to customers; and
- non-supply risk, which captures the potential consequences of an asset failure, which may include safety and environmental costs, in addition to damage to adjacent assets or property.

In relation to supply risk, we adopt a probabilistic planning methodology which considers the likelihood and severity of critical network conditions and outages. The expected annual cost to customers associated with supply risk is calculated by multiplying the expected unserved energy (the expected energy not supplied based on the probability of the supply constraint occurring in a year) by the value of customer reliability (VCR).

In relation to non-supply risks, our approach monetises this risk by multiplying the following parameter estimates:

- the probability of asset failure;
- the cost of consequence of the asset failure;
- the likelihood of the consequence given the failure has occurred; and
- the number of assets to which the analysis relates.

The purpose of the cost benefit analysis that underpins the RIT-D assessment is to determine whether there is a cost effective option to mitigate the supply and non-supply risks (the aggregate 'risk-cost'). In order to be cost effective, the reduction in the aggregate risk-cost that an option is expected to provide must exceed the cost of implementing that option. The preferred option provides greatest expected net benefit, expressed in present value terms.

- In the absence of remedial action,

Figure 6 shows how the aggregate risk-cost will typically increase as the risk of asset failure and energy at risk increase over time. The optimal timing of the preferred option occurs when the annualised capital cost of that option (or the operating cost for a non-network option) is equal to the aggregate risk-cost.

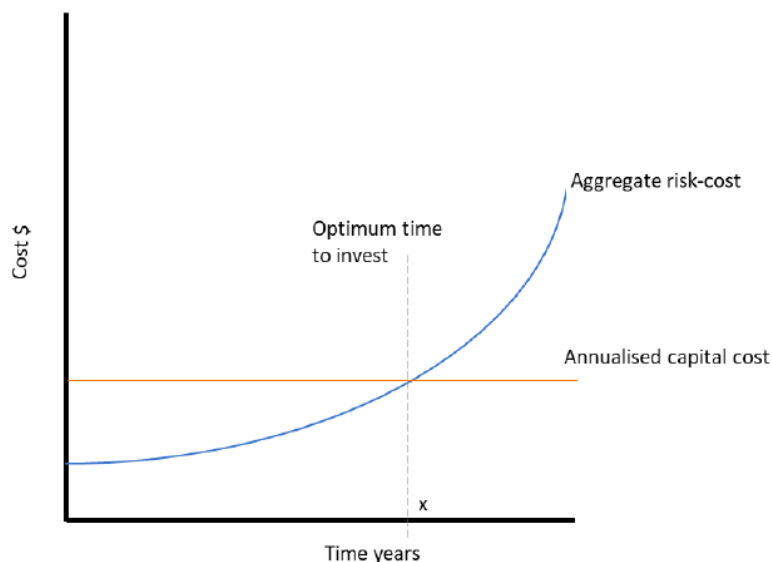

Figure 6: Increasing risk-cost over time and optimal project timing¹

¹ This figure is reproduced from the AER's Industry practice application note, Asset replacement planning, January 2019, figure 8. This figure assumes that the option eliminates the aggregate risk-cost in full, which may not be the case.

In effect, the preferred option delivers the lowest total cost to customers, which is the sum of the cost of implementing that option and any residual risk-cost. The identification of the preferred option is complicated by the fact that the future is uncertain and that various input parameters are ‘best estimates’ rather than known values. As a consequence, the RIT-D analysis must be conducted in the face of uncertainty.

To address uncertainty in our assessment of the credible options, we use sensitivity analysis and scenario analysis in our cost benefit assessment. As recommended by the AER’s application guidelines, we use sensitivity analysis to assist in determining an appropriate set of reasonable scenarios.² The relationship between sensitivity analysis and scenarios is best explained by the AER’s practice note:³

Scenarios should be constructed to express a reasonable set of internally consistent possible future states of the world. Each scenario enables consideration of the prudent and efficient investment option (or set of options) that deliver the service levels required in that scenario at the most efficient long run service cost consistent with the National Electricity Objective (NEO).

Sensitivity analysis enables understanding of which input values (variables) are the most determinant in selecting the preferred option (or set of options). By understanding the sensitivity of the options model to the input values a greater focus can be placed on refining and evidencing the key input values. Generally the more sensitive the model output is to a key input value, the more value there is in refining and evidencing the associated assumptions and choice of value.

Scenario and sensitivity analyses should be used to demonstrate that the proposed solution is robust for a reasonable range of futures and for a reasonable range of positive and negative variations in key input assumptions. NSPs should explain the rationale for the selection of the key input assumptions and the variations applied to the analysis.

In applying sensitivities and scenarios to our cost benefit assessment, we have regard to the particular circumstances to ensure that the approach is appropriate. Where our analysis shows that an option is clearly preferred, we will not undertake further testing. This approach is consistent with clause 5.17.1(c)(2) of the Rules, which states that the RIT-D must not require a level of analysis that is disproportionate to the scale and likely impact of each credible option considered.

In preparing the RIT-D, we have also had regard to AEMO’s 2021 Inputs, Assumptions and Scenarios Report and its 2022 Integrated System Plan (ISP). We note that the scenarios adopted by AEMO are focused particularly on the matters that are relevant to major transmission investments, rather than distribution investments of the type considered in this report. Accordingly, we have adopted an approach that is appropriate to the particular circumstances described in this report relating to the identified need and the credible options.

6.3 Key variables and assumptions

Table 7 below lists the key variables and assumptions applied in the economic assessment, which are essential inputs to our methodology described above. The table also sets out the upper and lower bounds of the range of forecasts adopted for each of these variables. As explained above, the lower bound and upper bound estimates are used to undertake sensitivity testing and scenario analysis. The detailed results of this modelling is provided in section 6.4.

² AER, Application guidelines, Regulatory investment test for distribution, December 2018, page 42.

³ AER, Asset replacement planning, January 2019, page 36.

Table 7: Key variables and assumptions (\$M)

Variable / assumption	Lower bound	Central estimate	Upper bound
Demand forecasts	5% reduction in central estimate of annual growth rate	Average annual growth rate of 2.3%	5% increase in central estimate of annual growth rate
Cost of involuntary supply interruption	25% reduction in central estimate	Value of Customer Reliability (VCR) of \$46,006 per MWh ⁴	25% increase in central estimate
Safety cost	Central Estimate	Value of statistical life of \$4.5 million ⁵	Central estimate
Safety cost Disproportionate Factor	Central estimate	Factor of 3	Central estimate
Option cost	15% reduction in central estimate	In-house cost estimates using detailed and high-level project scopes	15% increase in central estimate
Real discount rate per annum⁶	2.0%	5.5%	7.5%
Probability of asset failure	25% reduction in central estimate	Historical asset performance data, plus forecasts based on condition monitoring and CBRM modelling	25% increase in central estimate

Source: AusNet Services, BN_V6.0_Economic_Model-Master_Template_28-03-22

6.4 Cost benefit analysis

The economic analysis presented below allows comparison of the economic cost and benefits of each option to rank the options and to determine the optimal timing of the preferred option. It quantifies the capital costs and the cost of the residual risk for each option, to determine a total cost for each option. The net economic benefit for each credible option is the total cost associated with that option minus the costs of the 'Business as Usual' option.

As each of the credible options involves the replacement of existing assets, we have assumed that the operating cost for each option is unchanged from the 'Business as Usual' option. For the purpose of this RIT-D, we consider this approach to be a reasonable working assumption. The capital cost for each option has been described in section 5 of this DPAR.

We present our analysis as follows:

⁴ Calculated using the latest VCR estimates for each sector, refer to model 'Inputs – Global' tab.

⁵ Best Practice Regulation Guidance Note Value of statistical life, December 2014, escalated, refer to model 'Inputs – Global' tab.

⁶ The discount rates are consistent with AEMO's 2021 Inputs, Assumptions and Scenarios Report.

Service constraints at BN – Draft Project Assessment Report

- Section 6.4.1 presents the NPV analysis using central estimates; and
- Section 6.4.2 presents the sensitivity testing and scenarios analysis.

6.4.1 Present value analysis using central estimates

Table 8 presents the annualised net economic benefit of each credible option for each year and highlights the option with the highest net economic benefit, assuming the central estimates for the key variables presented in the previous section. For each option, we have selected the optimal timing or indicated for some options that the solution will not deliver a net benefit over the study period.

It should be noted that a residual risk-cost and benefit also applies for each option, which captures the costs and benefits beyond 2031. We have not shown the residual costs and benefits for each option in the table below, but it is considered in our PV analysis which is reported later in this section.

Table 8: Annualised net economic benefit (\$M)

	2022	2023	2024	2025	2026	2027	2028	2029	2030	2031
Option 1	0.0	0.0	0.0	0.0	0.0	0.0	0.0	0.0	0.0	0.0
Option 2	This option is no longer considered credible, as explained in section 5.2.									
Option 3	This option is no longer considered credible, as explained in section 5.3.									
Option 4	This option is no longer considered credible, as explained in section 5.4 Error! Reference source not found.									
Option 5	0.000	0.526	0.604	0.685	0.769	0.855	0.944	1.037	1.133	1.224
Option 6	0.000	0.538	0.627	0.721	0.818	0.918	1.020	1.128	1.239	1.345
Option 7	0.000	0.081	0.170	0.264	0.361	0.461	0.563	0.671	0.782	0.887

Source: AusNet Services, BN_V6.0_Economic_Model-Master_Template_28-03-22

As explained in the table above, Options 2, 3 and 4 are no longer considered to be credible options and are not considered further in this RIT-D assessment. Of the remaining options, Option 6 provides greater net benefits in each year to 2031.

While the above table is useful in understanding how the options compare with one another in the early years following their implementation, the analysis required by the RIT-D must consider the relative performance of the credible options over the life of the asset. Accordingly, the following table shows that the present values for each option over its life, using our central estimates, based on the optimal timing for each option.

Table 9: Net economic benefit (\$M)

	PV of risk reduction Benefit	PV of Option costs	PV of net economic benefit
Option 1	0.0	0.0	0.0
Option 2	Not a credible option		
Option 3	Not a credible option		
Option 4	Not a credible option		

Service constraints at BN – Draft Project Assessment Report

	PV of risk reduction Benefit	PV of Option costs	PV of net economic benefit
Option 5	\$24.90	\$8.08	\$16.82
Option 6	\$28.02	\$9.70	\$18.32
Option 7	\$26.93	\$15.99	\$10.94

Source: AusNet Services, BN_V6.0_Economic_Model-Master_Template_28-03-22

The present value analysis shown in Table 9 shows that Option 6 is preferred to the remaining credible options and the 'Business as Usual' option because it delivers the highest expected net benefit over the expected life of the investment, based on our central estimates.

6.4.2 Sensitivity testing and scenario analysis

As explained in section 6.2, we undertake sensitivity testing to examine how the net benefit for each option would be affected if certain parameters were varied. In this instance, we considered variations in the risk of asset failure; demand; the cost of each option; and the discount rate. The results of this analysis is presented below.

Table 10: Net benefit - sensitivity testing (\$M)

	High asset failure	Low asset failure	High demand	Low demand	High option cost	Low option cost	High discount rate	Low discount rate
Option 1	0.0	0.0	0.0	0.0	0.0	0.0	0.0	0.0
Option 2	Not a credible option							
Option 3	Not a credible option							
Option 4	Not a credible option							
Option 5	30.80	5.95	17.55	16.08	15.60	18.03	10.71	26.69
Option 6	34.05	6.09	19.17	17.47	16.86	19.77	11.44	29.45
Option 7	26.75	0.34	11.87	10.17	8.55	13.57	4.53	22.12

Source: AusNet Services, BN_V6.0_Economic_Model-Master_Template_28-03-22

The sensitivity analysis shows that Option 6 continues to deliver a net benefit against each of these changes in parameter assumptions, which provides strong assurance that the project delivers a net benefit across a broad range of different parameter inputs. To test our results further, we have adopted four scenarios, as set out below.

Service constraints at BN – Draft Project Assessment Report

Table 11: Definition of reasonable scenarios

Scenario	Probability of failure	Option Cost	Forecast Demand	VCR	Discount rate
Central Case	Central estimate	Central estimate	Central estimate	Central estimate	Central estimate
Low demand	Central estimate	Central estimate	Lower bound	Central estimate	Central estimate
Weak economic growth	Central estimate	Lower bound	Lower bound	Central estimate	Lower bound
High demand	Central estimate	Upper bound	Upper bound	Central estimate	Upper bound

Table 12 below provides a brief description of each scenario.

Table 12: Guide to scenarios

Scenario	Description
Central Case	This scenario adopts the central estimate for each variable in the economic assessment. It represents the most likely outcome.
Low demand	This scenario represents low demand driven by an increase in distributed energy resources. We have retained the other parameters at their central estimates, noting that the scenario is not driven by weak economic growth.
Weak economic growth	This scenario reflects weak economic growth, possibly as a result of the continuing impact of COVID-19. It has lower costs of delivering the option, lower demand and a lower discount rate
High demand	This scenario represents an economic rebound and continuing supply side issues. It is characterised by higher costs of delivering the option, higher demand and an upper bound discount rate.

Table 13: Net benefit for each scenario (\$M)

	Central case	Low demand	Weak economic growth	High demand
Option 1	0.0	0.0	0.0	0.0
Option 2	Not a credible option			
Option 3	Not a credible option			
Option 4	Not a credible option			
Option 5	16.82	16.08	26.87	10.06
Option 6	18.32	17.47	29.72	10.62
Option 7	11.02	10.17	23.50	3.16

Source: AusNet Services, BN_V6.0_Economic_Model-Master_Template_28-03-22

Service constraints at BN – Draft Project Assessment Report

On the basis of this scenario analysis, Option 6 is preferred to the other options, as it delivers a higher net economic benefit across each of the four scenarios.

6.5 Preferred option

The results of our cost benefit analysis is that Option 6 is the preferred option, which involves the following works:

- replace six 66 kV circuit breakers and associated primary and secondary assets in poor condition; and
- replace all 22 kV assets within the substation.

This option is expected to maximise the present value of the net economic benefit to all those who produce, consume and transport electricity in the NEM. Further details on the sequencing of works and cost estimates are provided in the Appendix.

Note: Assets operating at 22kV at BN are excluded from this scope as they are included for replacement as part of the REFCL program (DD-7180).

6.6 Capital and operating costs of the preferred option

The direct capital expenditure for the preferred option is \$8.95 million, excluding management reserve and capitalised overheads, as shown in the table below.

Table 14: Summary of capital expenditure requirements, \$'000, \$2021

	FY23	FY24	FY25	FY26	FY27	Total
Design	177.8	625.6	-	9.4	-	812.8
Internal labour	76.6	156.3	455.6	348.5	11.9	1,048.9
Materials		152.7	1,245.8	1,111.9		2,510.4
Plant and equipment		44.8	274.1	256.3		575.2
Contracts		311.9	1,909.0	1,784.9		4,005.8
Total	254.4	1291.3	3884.5	3511.0	11.9	8,953.1

Source: AusNet Services, DD-0003285 - BENALLA 66kV Rebuild - Business Case RevB

Note: Excludes overheads, management reserve, written down value of assets retired/sold.

The operating expenditure associated with this option will relate to the on-going inspection and maintenance of the assets. Our assessment is that a reasonable estimate of the annual operating expenditure is approximately 1.2% of the direct capital cost of the asset, which equates to approximately \$100k per annum.

In relation to the timetable for completing these works, we expect to publish the FPAR in September 2022, allowing the construction to commence from October 2023 onwards with commission readiness scheduled for 30 March 2026. The project is expected to reach completion by June 2026.

7 Satisfaction of the RIT-D

In accordance with clause 5.17.4(j)(11)(iv) of the NER, we certify that the proposed option satisfies the regulatory investment test for distribution. The table below shows how each of these requirements have been met by the relevant section of this report.

Table 15: Compliance with regulatory requirements

Requirement	Section
5.17.4(j) The draft project assessment report must include the following:	
(1) a description of the identified need for the investment;	Section 3.
(2) the assumptions used in identifying the identified need (including, in the case of proposed reliability corrective action, reasons that the RIT-D proponent considers reliability corrective action is necessary);	Section 4.
(3) if applicable, a summary of, and commentary on, the submissions on the non-network options report;	No submissions were received.
(4) a description of each credible option assessed;	Section 5.
(5) where a Distribution Network Service Provider has quantified market benefits in accordance with clause 5.17.1(d), a quantification of each applicable market benefit for each credible option;	Section 6.4.
(6) a quantification of each applicable cost for each credible option, including a breakdown of operating and capital expenditure;	Sections 5 and 6.4.
(7) a detailed description of the methodologies used in quantifying each class of cost and market benefit;	Section 6.2.
(8) where relevant, the reasons why the RIT-D proponent has determined that a class or classes of market benefits or costs do not apply to a credible option;	Section 6.1.
(9) the results of a net present value analysis of each credible option and accompanying explanatory statements regarding the results;	Section 6.4.
(10) the identification of the proposed preferred option;	Section 1.1 and 6.5.
(11) for the proposed preferred option, the RIT-D proponent must provide:	
(i) details of the technical characteristics;	Appendix.
(ii) the estimated construction timetable and commissioning date (where relevant);	Section 6.6.
(iii) the indicative capital and operating cost (where relevant);	Section 6.6.
(iv) a statement and accompanying detailed analysis that the proposed preferred option satisfies the regulatory investment test for distribution; and	Section 7, including this table.

Service constraints at BN – Draft Project Assessment Report

Requirement	Section
(v) if the proposed preferred option is for reliability corrective action and that option has a proponent, the name of the proponent;	Not applicable.
(12) contact details for a suitably qualified staff member of the RIT-D proponent to whom queries on the draft report may be directed.	Section 1.3.
5.17.4(k) The RIT-D proponent must publish a request for submissions on the matters set out in the draft project assessment report, including the proposed preferred option, from:	
(1) Registered Participants, AEMO, non-network providers and interested parties; and	Section 1.3.
(2) if the RIT-D proponent is a Distribution Network Service Provider, persons on its demand side engagement register.	
5.17.4(l) If the proposed preferred option has the potential to, or is likely to, have an adverse impact on the quality of service experienced by consumers of electricity, including:	
(1) anticipated changes in voluntary load curtailment by consumers of electricity; or	
(2) anticipated changes in involuntary load shedding and customer interruptions caused by network outages, then the RIT-D proponent must consult directly with those affected customers in accordance with a process reasonably determined by the RIT-D proponent.	Not applicable.
5.17.4(m) The consultation period on the draft project assessment report must not be less than six weeks from the publication of the report.	Section 1.3.

Appendix – Technical Characteristics

Scope of works

Almost all major switchyard equipment are to be replaced due to their poor condition. These are:

- All six 66kV Bulk Oil Circuit Breakers for GNTS#1, GNTS#2, MSD, No.1, 2 and 3 66/22kV transformers
- All thirteen 66kV isolators on the line bay, transformer bays and tie bus
- Cap and Pin Post insulators

Two VTs and fused isolators are to be replaced under DD-0006945, and will be completed by 16/12/2022.

It is a considerable challenge to maintain continuity of customer supply throughout the replacement programme. This complication comes about because:

- MSD is on a radial feeder without any alternative source of supply.
- The MSD-No.1 Bus Tie is not equipped with breaker meaning that the No.1 bus will trip for a line fault when the tie is closed.
- The BN 22kV load demand takes two transformers to fulfil.

It is also not desirable to re-string overhead spans over live bus. This rules out relocating the GNTS#2 line exit which supplies the No.2 Bus over a live No.1 Bus or relocating the No.1 transformer line exit fed from the No.1 Bus over a live No.2 Bus as these lead to station black scenarios.

The single line proposed is shaped by a staging programme which provides cost-effective support for continuity of customer supply. The single line is shown on Fig.1.

The staging starts with an extension of the switchyard south by a double switched bay for the MSD line. The land belongs to AusNet without any sub-lease to encumber its use, but the fence to be relocated south by 8m for the switchyard bench. This staging reduces MSD outage which involves customer outage notification over a wide area to just one. There are occasions in stringing No.2 or 3 transformers exit when only transformer is in service and mobile generators have to be installed.

The line traps at the GNTS line entries are to be dismantled as comms PLC is no longer in use. The CVTs are to be decommissioned and removed. The VTs under DD-0006945 are proposed to be installed at these locations and Bus voltages are to be derived through a new Pot Selector panel.

The secondary panels to be replaced are

- All protection for the three 66kV lines and two Main Buses;
- X 250Vdc distribution board; and
- 415V ac distribution board.

These are to be installed in the existing control building after the new 22kV and transformer protection have been commissioned in the new control building under the REFCL project. Decommissioning and removal of the old 22kV prot panels will free up space at western end of the old control building. After relocating the few steel frame inserts that remains, dismantling of the legacy insert frame, low secondary DC bus and asbestos blackboard panels may proceed to free up space. As the control room is just over 2m wide, the new panels will be arranged as one row of freestanding cubicles.

The 415V ac distribution board is to be configured as a sub-board to new 415kV in new control building.

Note: Assets operating at 22kV at BN are excluded from this scope as they are included for replacement as part of the REFCL program (DD-7180).

Figure 7: Single Line Diagram of proposed 66kV Rebuild

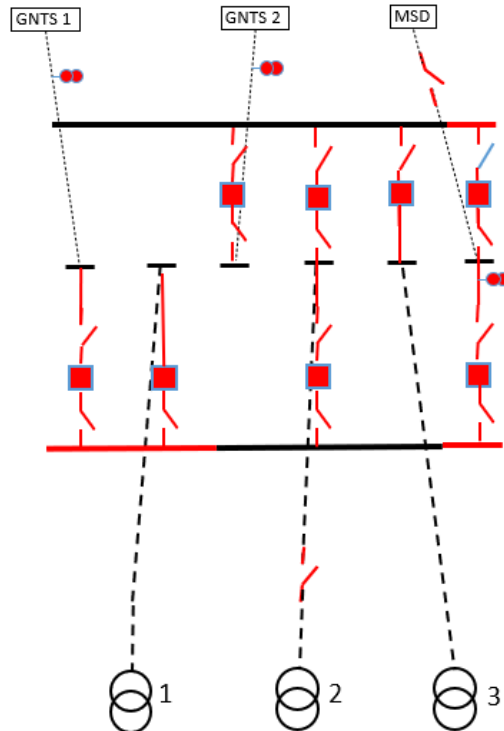

Technical assumptions

The following technical assumptions and clarifications are made:

1. All rating, sizing, plant and cable, dimensioning and volume allowance of materials and areas is for Business Case Estimation purposes and not to be used as a design scope. All rating and sizing calculations are to be completed and verified during detailed design.
2. The staging is for Business Case Estimation purposes and not to be used as a design scope. The actual staging is to be reviewed against fresh load information and verified during construction.
3. Structures for underslung isolators may be reused after strengthening with a horizontal member and packers added to adjust for different 66kV insulator lengths.
4. Footings for underslung isolator structures can be reused after augmentation.
5. Existing racks may be reused without strengthening to 31.5kA for 66kV. No analysis of rack will be carried out in conjunction with replacement of glass insulating strings.
6. Assume possible to reuse existing switchyard trenches.
7. The new SCIMS panels will have adequate serial/ ethernet ports to interface the new IEDs being added as part of the project.

Sequencing of works

At a high level the project stages will be:

1. At 66kV switchyard, relocate substation fence and extend substation bench southwards. Install new double switched MSD bay. Keep old MSD bay with protection to assist staging.
2. Demolish line traps and CVTs. Install new 66kV line VTs.
3. Divert MSD line to new bay. Commission new VTs with new pot selection panel.
4. Demolish 66kV tie bus and install new double switched bay.
5. Connect No.2 transformer to new double switched bay.
6. Construct new single switched bays for GNTS lines and other transformers.
7. Reconnect GNTS lines and other transformers. Commission new single switched bays.

Note: Assets operating at 22kV at BN are excluded from this scope as they are included for replacement as part of the REFCL program (DD-7180)